

Type VC-U smd ceramic package (2.0 ~ 47)MHz

- # **tight symmetry**
- # **(7.5 x 5.0)mm footprint**
- # **+3.3Vd.c., +5.0Vd.c. supply**

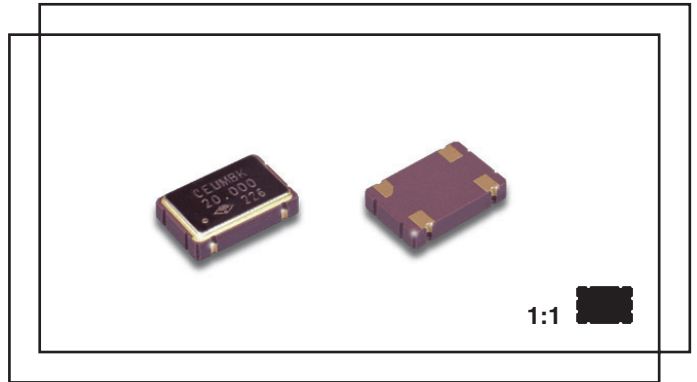

Electrical specification

Case style	C: (7.5 x 5.0)mm, height 1.8mm		
Frequency range	(2.0 ~ 47)MHz		
Stability *	$\pm(25 \sim 50)$ ppm, temperature range dependent		
Pulling range	± 100 ppm min.		
Control voltage V_t	$(+2.5 \pm 2.0)$ Vd.c., $V_{cc} = +5.0$ Vd.c., $(+1.65 \pm 1.35)$ Vd.c., $V_{cc} = +3.3$ Vd.c.		
Supply voltage V_{cc}		+3.3Vd.c.	+5.0Vd.c.
Supply current max.	(2.0 ~ 20)MHz	10mA	15mA
	(20 ~ 47)MHz	20mA	40mA
Rise and fall time max. **	(2.0 ~ 20)MHz	10ns	8ns
	(20 ~ 47)MHz	6ns	5ns
Operating temperature	$(-20 +70)^\circ\text{C} \sim (-40 +85)^\circ\text{C}$		
Storage temperature	$(-40 +125)^\circ\text{C}$		
Output	CMOS 15pF, CMOS 50pF		
Symmetry	$(45 \sim 55)\%$, $(40 \sim 60)\%$		
Ageing	± 5 ppm first year max.		

* inclusive of calibration tolerance at $+25^\circ\text{C}$, temperature tolerance, supply voltage variation, load variation, first year ageing, shock and vibration.

** measured, with an output load of 15pF, between $(10 \sim 90)\% V_{cc}$

Ordering information

Example type VC-U smd clock oscillator, 40.00MHz, ± 100 ppm pulling range, +3.3Vd.c., ± 25 ppm $(-20 +70)^\circ\text{C}$, output CMOS 15pF, symmetry $(45 \sim 55)\%$

TFC PART NUMBER VC 40.0M E U M C J

'VC' type number: VC = smd clock oscillator type VC

'40.0M' frequency: 40.0M = 40.00MHz, frequency range from (2.0 ~ 47)MHz

'E' supply voltage: E = +3.3Vd.c., C = +5.0Vd.c.

'U' VCXO designator

'M' frequency stability: M = ± 25 ppm

'C' temperature range: C = $(-20 +70)^\circ\text{C}$

'J' output logic and symmetry: J = CMOS 15pF, $(45 \sim 55)\%$

Frequency stability M: ± 25 ppm, P: ± 50 ppm,

Temperature range C: $(-20 +70)^\circ\text{C}$, L: $(-40 +85)^\circ\text{C}$

Output J: CMOS 15pF $(45 \sim 55)\%$, F: CMOS 50pF $(45 \sim 55)\%$,

K: CMOS 15pF $(40 \sim 60)\%$, G: CMOS 50pF $(40 \sim 60)\%$

Type VC-U

VC-U dimensions(mm) shown twice full size

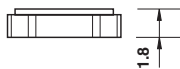
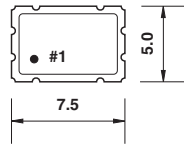

Suggested land pattern

Pads are gold, 2.5µ min., over nickel, suitable for vapour phase or reflow soldering, preheat +150°C for 2 minutes, peak temperature +250°C for 30 seconds max.

Connect 0.01µF capacitor between Vcc and ground

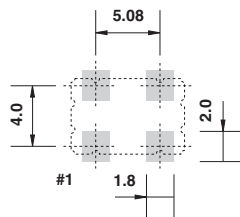
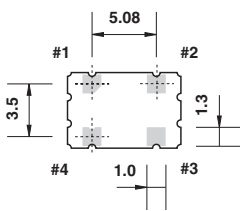

Pads viewed from bottom

- #1 voltage control
- #2 ground
- #3 output
- #4 Vcc

Tape and reel dimensions(mm)

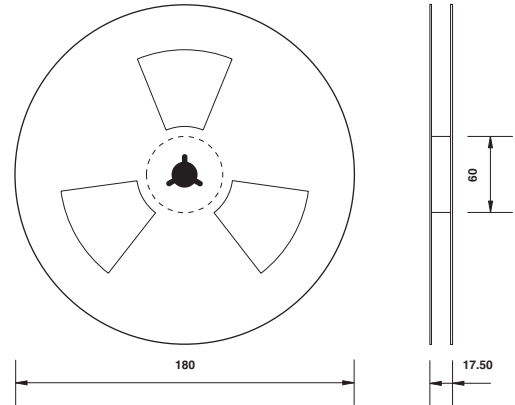

Centre hole diameter 13.0mm, slot width 2mm spaced at 120°
Reel quantity 1000 pieces, leader tape 400mm minimum

Trailer tape: 10 empty compartments minimum

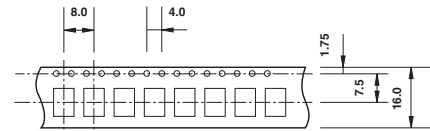

Tape transport hole diameter 1.5mm, 4.0mm pitch
Compartment size 8.18mm x 5.56mm, depth 2.16mm
Component spacing on 8.0mm pitch

Environmental test conditions

Mechanical shock	1500g, half sine wave, 0.5ms, 3 directions	MIL STD 883D 2002.3, condition A
Thermal shock	(-55 ~ +125)°C, 20 cycles	MIL STD 883D 1011.9, condition B
Vibration	(10 ~ 2000)Hz, 1.25mm, sine wave, 20g, each of three planes, duration 4 hours	MIL STD 883D 2005.2, condition B
Solderability	+245°C ±5°C, 5 seconds ±0.5 seconds	MIL STD 883D 2003.7
Fine leak	Mass spectrometer leak rate less than 2 ¹⁰⁻⁸ atm.cc/sec. helium	MIL STD 883D 1014.9, condition A
Gross leak	Leak test in de-ionised water, vacuum 70cm/Hg	
Humidity	85% relative humidity, +85°C, 500 hours	JIS-C 7022 B-5, condition C