

Type TC TCXO (10.0 ~ 40.0)MHz

- # very low power
- # miniature smd package
- # (7 x 5)mm footprint
- # +(2.8 ~ 3.3)Vd.c., +5.0Vd.c. supply
- # RoHS Compliant

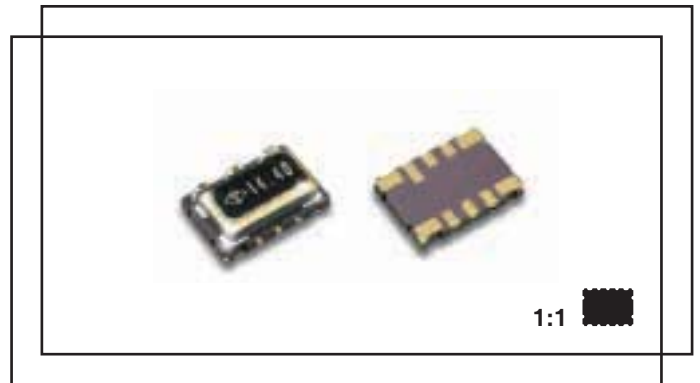

Electrical specification

Case style	type TC: (7 x 5)mm, height 2.0mm	
Frequency range	(10.0 ~ 40.0)MHz	
Frequency tolerance	at 25°C (1 hour after reflow)	±2ppm
Frequency stability -vs-	temperature	±(0.5 ~ 5.0)ppm
	±5% supply voltage change	±0.2ppm max.
	±10% load change	±0.2ppm max.
	ageing	±1.0ppm per year max.
Supply voltage V_{cc}	+(2.8 ~ 3.3)Vd.c., +5.0Vd.c.	
Supply current max.	(10 ~ <15)MHz	1.5mA
	(15 ~ <26)MHz	2.0mA
	(26 ~ 40)MHz	2.5mA
Phase noise @ 13MHz	f ₀ +100Hz	-115dBc/Hz
	f ₀ +1kHz	-135dBc/Hz
	f ₀ +10kHz	-148dBc/Hz
Operating temperature	(0 +55)°C ~ (-40 +85)°C	
Storage temperature	(-55 +125)°C	
Output	0.8Vp/p, clipped sine wave 10k//10pF	
Trim range	fixed frequency or voltage trim	
Ageing	±1.0ppm first year max.	

Environmental test conditions

Mechanical shock	1500g, half sine wave, 0.5ms, 3 directions	MIL STD 883D 2002.3, condition A
Thermal shock	(-55 ~ +125)°C, 20 cycles	MIL STD 883D 1011.9, condition B
Vibration	(10 ~ 2000)Hz 1.25mm, sine wave, 20g, each of three planes, duration 4 hours	MIL STD 883D 2005.2, condition B
Solderability	+245°C ±5°C, 5 seconds ±0.5 seconds	MIL STD 883D 2003.7
Fine leak	Mass spectrometer leak rate less than 2 ¹⁰⁻⁸ atm.cc/sec. helium	MIL STD 883D 1014.9, condition A
Gross leak	Leak test in de-ionised water, vacuum 70cm/Hg	
Humidity	85% relative humidity, +85°C, 500 hours	JIS-C 7022 B-5, condition C

Type TC TCXO

Ordering information

Example type TC TCXO, 10.00MHz, +5.0Vd.c., ±5ppm trim, ±2.5ppm(-20 +70)°C, clipped sine wave o/p

TFC PART NUMBER TC 10.00M C A D C S

'TC' type number: TC = TCXO type TC

'10.00M' frequency: 10.00M = 10.00MHz, frequency range from (10.0 ~ 40.0)MHz

'C' supply voltage: C = +5.0Vd.c.

'A' trim range, pin #1, input impedance 1Meg Ohm: A = ±5.0ppm voltage trim, control voltage (1.5 ±1.0)Vd.c.

'D' frequency stability: E = ±2.5ppm

'C' temperature range: I = (-20 +70)°C

'S' output: S = clipped sine wave output 10kΩ//10pF

Supply voltage	C: +5Vd.c., E: +(2.8 ~ 3.3)Vd.c.
Trim range, pin #1, V_t (+1.5 ±1.0)Vd.c.	A: ±5.0ppm voltage trim, B: ±8.0ppm voltage trim C: ±10.0ppm voltage trim T: fixed frequency TCXO, no voltage trim
Frequency stability	A: ±0.5ppm, B: ±1.0ppm, P: ±1.5ppm, C: ±2.0ppm D: ±2.5ppm, E: ±3.0ppm, F: ±4.0ppm, G: ±5.0ppm
Temperature range	B: (0 +55)°C, I: (-10 +60)°C, C: (-20 +70)°C, D: (-30 +85)°C, L: (-40 +85)°C

Dimensions(mm) shown twice full size

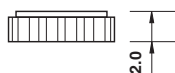
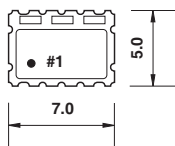

Suggested land pattern

Pads are gold, 2.5µ min., over nickel, suitable for vapour phase or reflow soldering, preheat +150°C for 2 minutes, peak temperature +250°C for 30 seconds max.

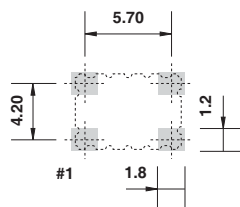
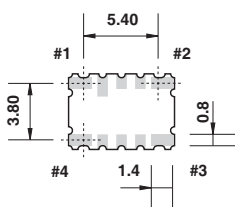

Pads viewed from bottom

- #1 vcxo: trim, tcxo: n/c
- #2 ground
- #3 output
- #4 Vcc

Tape and reel dimensions(mm)

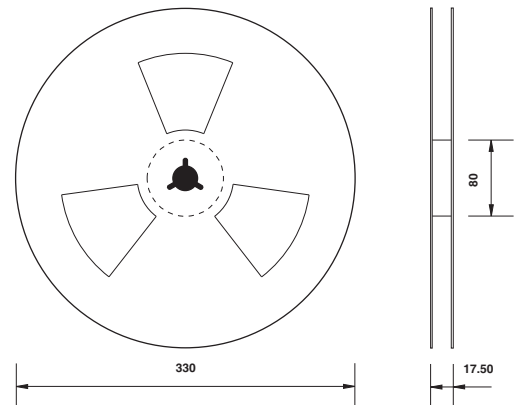

Centre hole diameter 13.0mm, slot width 2mm spaced at 120°
Reel quantity 1000 pieces, leader tape 400mm minimum
Trailer tape: 10 empty compartments minimum

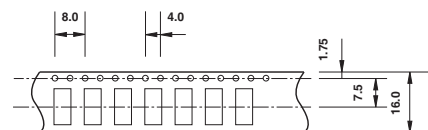

Tape transport hole diameter 1.5mm
Compartment size 5.56mm x 8.18mm, depth 2.16mm
Component spacing 8.0mm